

AL-LED-L1-X-290-8XX-NM

LED AREA LIGHT FIXTURES



Compact 290W High-Performance LED Area Light,
120–277V Input, Bronze Housing,
Multiple Mounting, Optics, and Control options

PRODUCT FEATURES

- Compact, low-profile design delivers high-performance illumination and improves application site aesthetics
- Heavy-duty, die-cast aluminum housing with ample heat sinking for enhanced thermal performance
- True U0 design for Dark Sky compliant performance eliminates undesirable sky glow
- Integrated NEMA/ANSI C136.10 3-pin twist-lock receptacle with shorting cap, standard on all fixtures, simplifies ordering requirements for photo control needs
- Precision-crafted optics, available with type II, III, IV, and V patterns, to meet diverse requirements from general purpose to specification-grade applications
- Integral latch design for hassle-free, hinged access to driver compartment
- Four contractor-friendly mounting options available (sold separately): slip fitter mount, adjustable pole mount for square and round poles, fixed pole mount for square and round poles, and trunnion mount
- Bi-level occupancy sensors and twist-lock photocell accessories available
- Reversible glare shield available, suitable for backside (house-side) or frontside (street-side) shielding
- Powered by 0–10V dimming LED driver featuring 12V AUX power tap, 6kV surge protection
- Ambient operating temperature: –40°C/–40°F to 50°C/122°F
- UL Certified for wet locations, IP65
- 0–10V dimming, 10% min
- Power factor: >0.95
- THD: <20%
- LED chip lifetime: L70 >100,000 hrs @ 25°C/77°F ambient fixture temp
- Meets FCC Part 15, Part B, Class A standards for conducted and radiated emissions



ELECTRICAL SPECIFICATIONS

Catalog Number	Wattage	Lumens	Efficacy	Dimming	Color Temp	CRI	Dist Type*	Input Voltage	Rated Life	Legacy Equivalent	Housing Color**	Additional Feature
AL-LED-L1-3-290-840-NM	290W	40,310 lm	139 lm/W	0–10V	4000K	>80	III	120–277V	50,000 hrs	1000W	Bronze	10kV external surge protection included
AL-LED-L1-3-290-850-NM		40,890 lm	141 lm/W		5000K		III					
AL-LED-L1-5-290-840-NM		40,600 lm	140 lm/W		4000K		V					
AL-LED-L1-5-290-850-NM		41,180 lm	142 lm/W		5000K		V					

* Fixtures with Type 2 (II) and Type 4 (IV) optics are available and assembled to order. Lead times may apply. Please see catalog number breakdown for full ordering code details.

** Fixtures (and mounts) with alternate housing colors are available and made to order. Extended lead times apply. Please see catalog number breakdown for full ordering code details.

AL-LED-L1-X-290-8XX-NM

LED AREA LIGHT FIXTURES

MOUNTING BRACKET OPTIONS (SOLD SEPARATELY)

SLIP FITTER MOUNT

Fits 2 3/8" tennon; Bronze

Catalog Number	UPC	Easy Code
KT-ALED-SF-1-KIT	843654131641	JRH-74



ADJUSTABLE POLE MOUNT

For round or square pole; Bronze

Catalog Number	UPC	Easy Code
KT-ALED-PMA-1-KIT	843654131634	DAQ-87



FIXED POLE MOUNT

For round or square pole; Bronze

Catalog Number	UPC	Easy Code
KT-ALED-PM-1-KIT	843654131627	QVG-29



TRUNNION MOUNT

Bronze

Catalog Number	UPC	Easy Code
KT-ALED-TM-1-KIT	843654131658	GTH-37

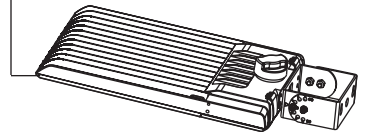
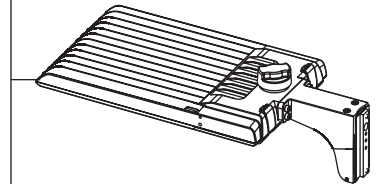
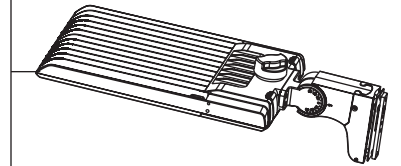
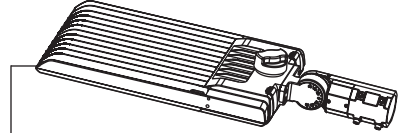
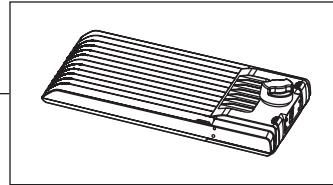

AL-LED-L1-X-290-8XX-NM

LED AREA LIGHT FIXTURES

PHYSICAL SPECIFICATIONS

LED AREA LIGHT FIXTURE

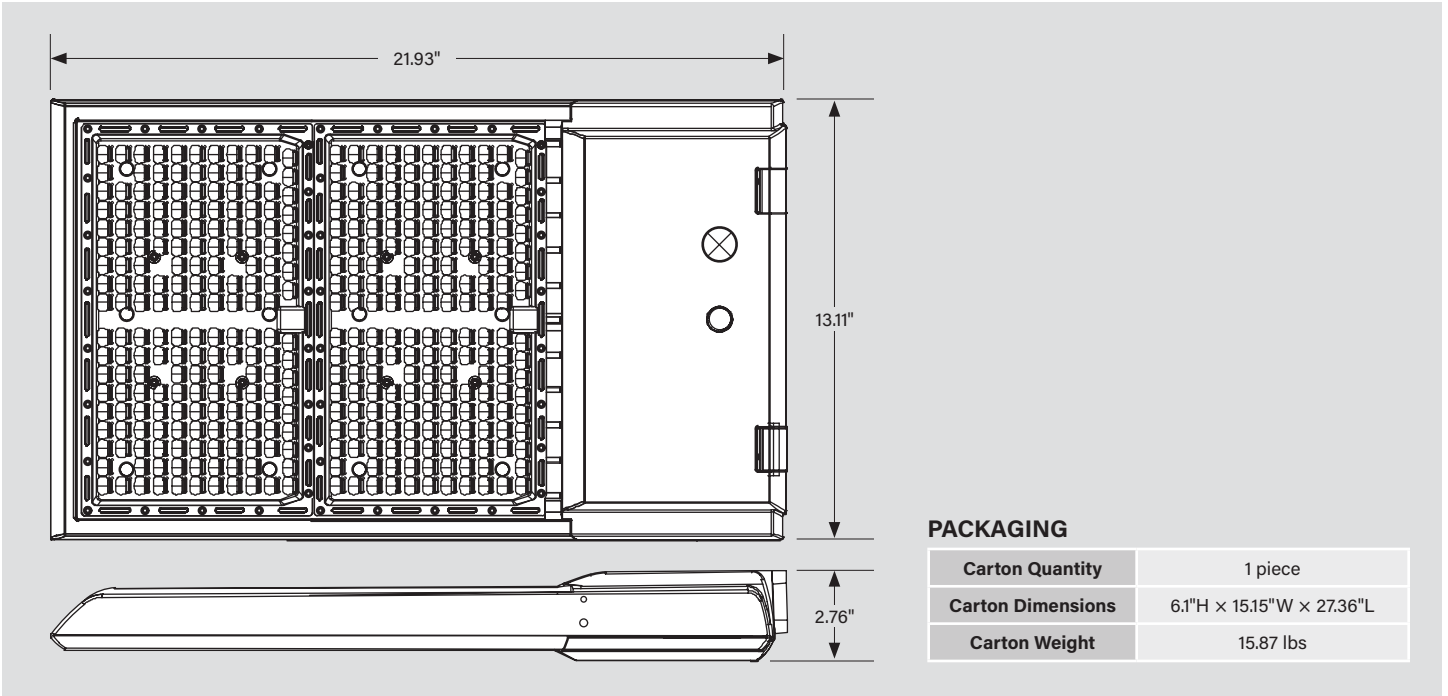

POLE MOUNT (ADJUSTABLE OR FIXED) DRILLING HOLES

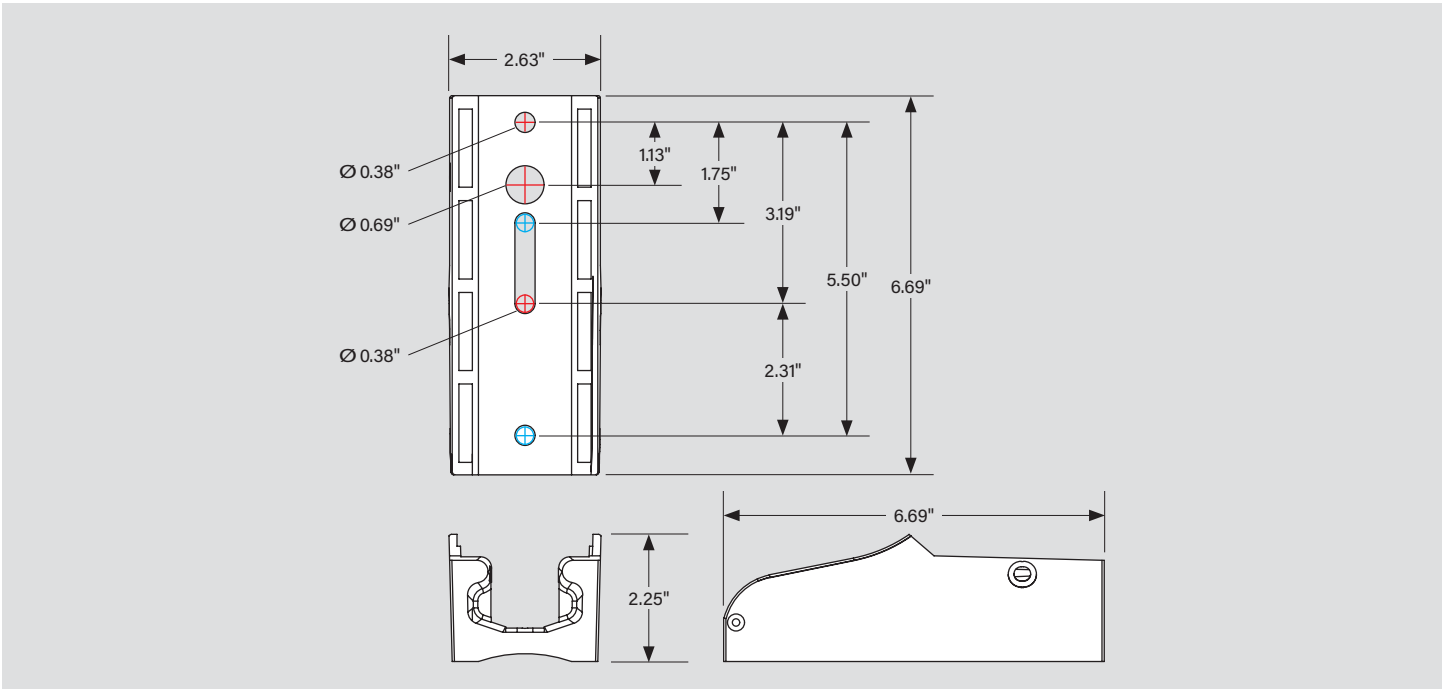

AL-LED-L1-X-290-8XX-NM

LED AREA LIGHT FIXTURES

WIRING DIAGRAM

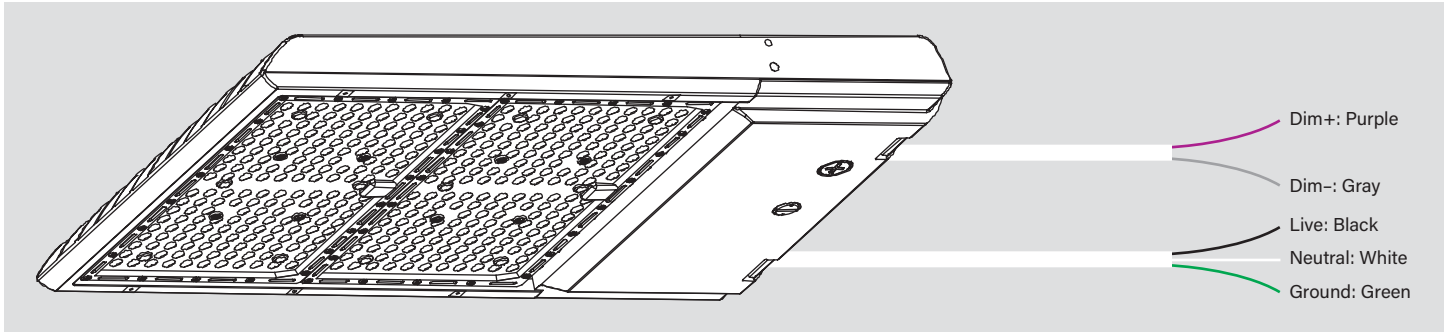

LIGHT DISTRIBUTION PATTERN

TYPE 3 (III)

Pole-mount view from above; Area light mounted at 35'

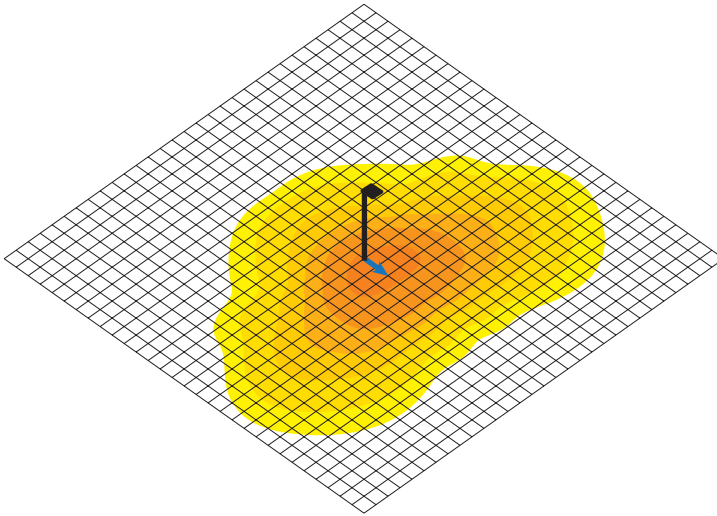

- Photometric layout for general reference only
- Grid dimension: 10 × 10 sq ft

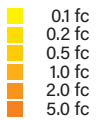

TYPE 5 (V)

Pole-mount view from above; Area light mounted at 35'

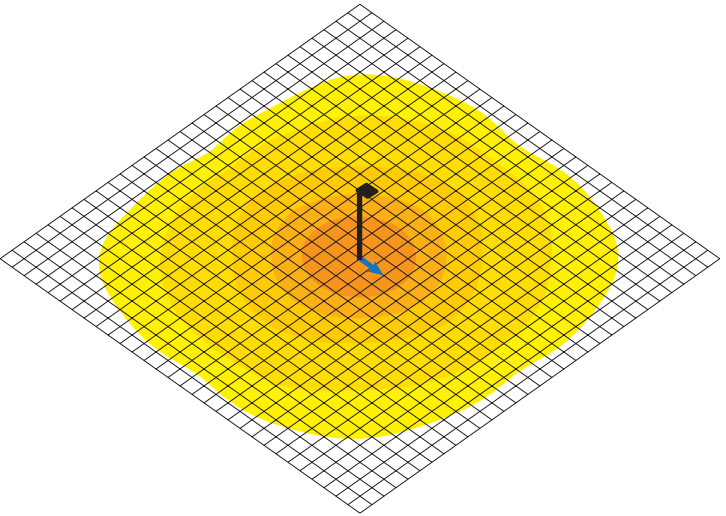

- Photometric layout for general reference only
- Grid dimension: 10 × 10 sq ft



AL-LED-L1-X-290-8XX-NM

LED AREA LIGHT FIXTURES

PHOTOMETRIC SPECIFICATIONS (TYPE 3 [III])

ISOCANDELA PLOT

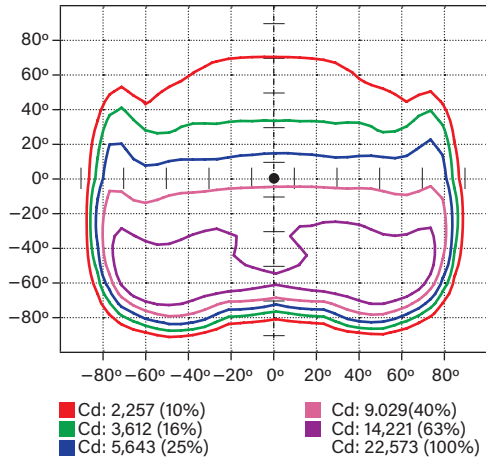

LUMINOUS INTENSITY DISTRIBUTION

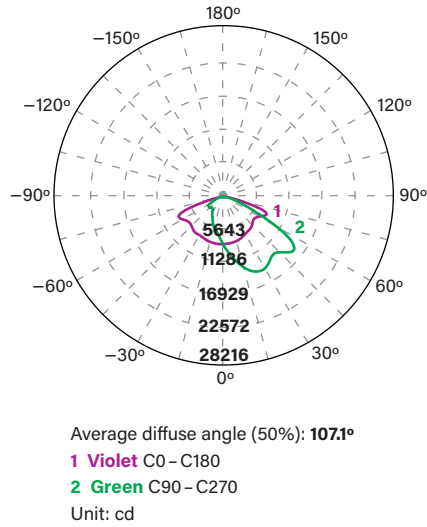

FLUX DISTRIBUTION

Zone	Lumens	% Luminaire
Forward Light	32,023 lm	78.3%
0°-30°	4,668 lm	11.4%
30°-60°	15,785 lm	38.6%
60°-80°	10,911 lm	26.7%
80°-90°	659 lm	1.6%
Back Light	8,879 lm	21.7%
0°-30°	2,381 lm	5.8%
30°-60°	4,201 lm	10.3%
60°-80°	2,134 lm	5.2%
80°-90°	163 lm	0.4%
Up Light	0 lm	0.0%
90°-100°	0 lm	0.0%
100°-180°	0 lm	0.0%

BUG* Rating

Asymmetrical Luminaire Types	
Type I, II, III, IV	B3 U0 G4
Quadrilateral Symmetrical Luminaire Types	
Type V, Area Light	B3 U0 G4

* Backlight, Uplight, Glare

PHOTOMETRIC SPECIFICATIONS (TYPE 5 [V])

ISOCANDELA PLOT

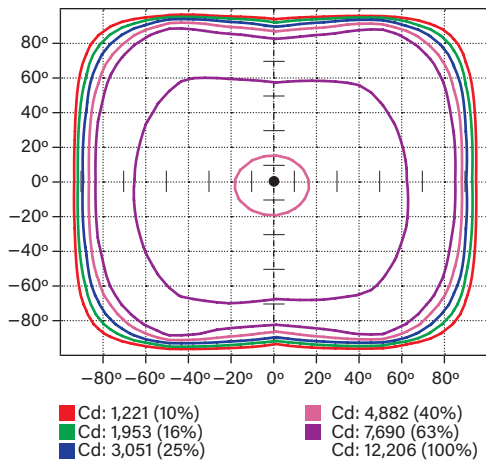

LUMINOUS INTENSITY DISTRIBUTION

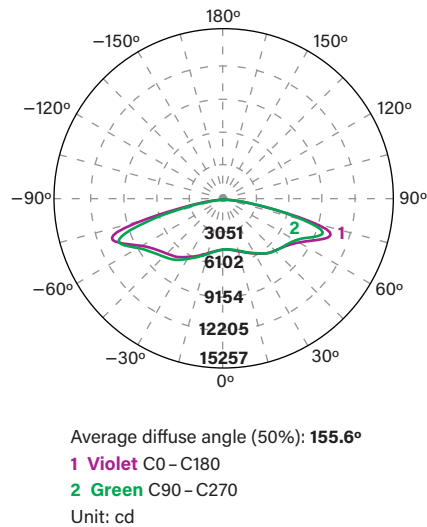

FLUX DISTRIBUTION

Zone	Lumens	% Luminaire
Forward Light	20,184 lm	49.1%
0°-30°	2,131 lm	5.2%
30°-60°	7,519 lm	18.3%
60°-80°	8,851 lm	21.6%
80°-90°	1,683 lm	4.1%
Back Light	20,884 lm	50.9%
0°-30°	2,231 lm	5.4%
30°-60°	8,135 lm	19.8%
60°-80°	9,332 lm	22.7%
80°-90°	1,186 lm	2.9%
Up Light	0 lm	0.0%
90°-100°	0 lm	0.0%
100°-180°	0 lm	0.0%

BUG* Rating

Asymmetrical Luminaire Types	
Type I, II, III, IV	B5 U0 G5
Quadrilateral Symmetrical Luminaire Types	
Type V, Area Light	B5 U0 G5

* Backlight, Uplight, Glare

AL-LED-L1-X-290-8XX-NM

LED AREA LIGHT FIXTURES

PHOTOMETRIC SPECIFICATIONS (TYPE 4 [IV])

ISOCANDELA PLOT

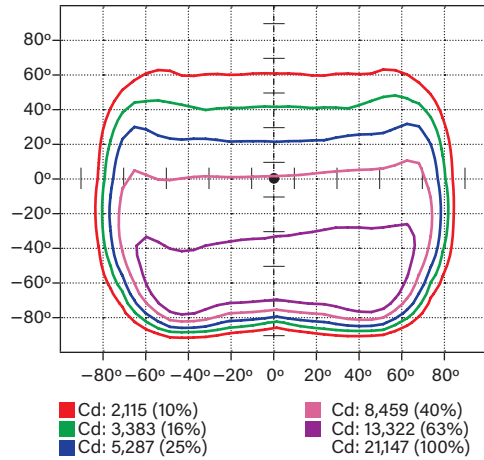

LUMINOUS INTENSITY DISTRIBUTION

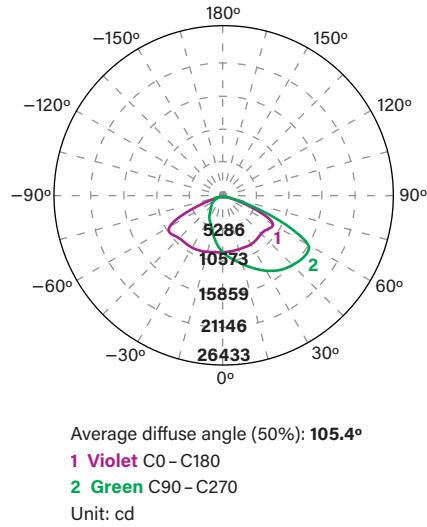

FLUX DISTRIBUTION

Zone	Lumens	% Luminaire
Forward Light	31,215 lm	75.7%
0°–30°	4,469 lm	10.8%
30°–60°	15,484 lm	37.6%
60°–80°	10,658 lm	25.9%
80°–90°	603 lm	1.5%
Back Light	9,996 lm	24.3%
0°–30°	2,730 lm	6.6%
30°–60°	4,942 lm	12.0%
60°–80°	2,099 lm	5.1%
80°–90°	225 lm	0.5%
Up Light	0 lm	0.0%
90°–100°	0 lm	0.0%
100°–180°	0 lm	0.0%

BUG* Rating

Asymmetrical Luminaire Types	
Type I, II, III, IV	B4 U0 G4
Quadrilateral Symmetrical Luminaire Types	
Type V, Area Light	B4 U0 G4

* Backlight, Uplight, Glare

PHOTOMETRIC SPECIFICATIONS (TYPE 2 [II])

ISOCANDELA PLOT

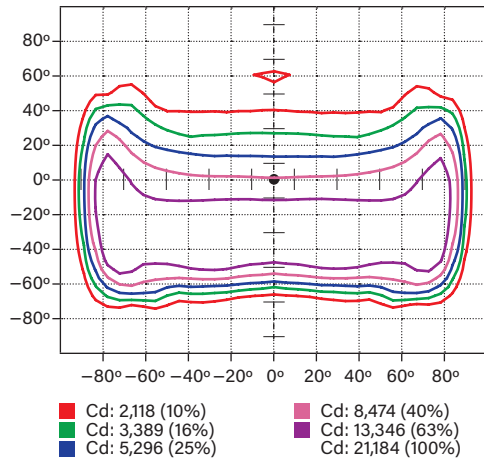

LUMINOUS INTENSITY DISTRIBUTION

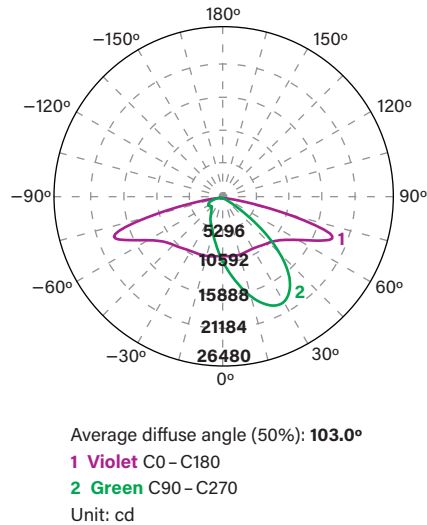

FLUX DISTRIBUTION

Zone	Lumens	% Luminaire
Forward Light	31,323 lm	76.3%
0°–30°	5,979 lm	14.6%
30°–60°	17,587 lm	42.8%
60°–80°	7,335 lm	17.9%
80°–90°	422 lm	1.0%
Back Light	9,727 lm	23.7%
0°–30°	2,462 lm	6.0%
30°–60°	4,158 lm	10.1%
60°–80°	2,882 lm	7.0%
80°–90°	226 lm	0.5%
Up Light	0 lm	0.0%
90°–100°	0 lm	0.0%
100°–180°	0 lm	0.0%

BUG* Rating

Asymmetrical Luminaire Types	
Type I, II, III, IV	B4 U0 G4
Quadrilateral Symmetrical Luminaire Types	
Type V, Area Light	B4 U0 G3

* Backlight, Uplight, Glare















AL-LED-L1-X-290-8XX-NM

LED AREA LIGHT FIXTURES

EPA SPECIFICATIONS

Large-Size Fixture Housing

Conditions: Horizontal winds only for calculations. Worst case total projected area used for calculations. All drag coefficients are set as worst case 1.2. For details on exact EPA calculations and assumptions, please contact your sales representative.

EPA Calcs (1.2*ft^2 View)		Single Fixture	2 Fixtures at 90°	2 Fixtures at 180°	3 Fixtures at 90°	3 Fixtures at 120°	4 Fixtures at 90°	2 Fixtures Side-by-Side	3 Fixtures Side-by-Side	4 Fixtures Side-by-Side
Mounting Application	Fixture Position									
Adjustable Pole Mount 	Horizontal	0.62 sq. ft.	0.90 sq. ft.	1.24 sq. ft.	1.42 sq. ft.	1.48 sq. ft.	1.42 sq. ft.	0.74 sq. ft.	1.11 sq. ft.	1.48 sq. ft.
Adjustable Pole Mount 	45°	1.85 sq. ft.	2.43 sq. ft.	1.85 sq. ft.	3.01 sq. ft.	4.42 sq. ft.	3.01 sq. ft.	3.70 sq. ft.	5.55 sq. ft.	7.40 sq. ft.
Slip Fitter Mount 	Horizontal	0.60 sq. ft.	0.98 sq. ft.	1.20 sq. ft.	1.53 sq. ft.	1.57 sq. ft.	1.53 sq. ft.	0.86 sq. ft.	1.30 sq. ft.	1.73 sq. ft.
Slip Fitter Mount 	45°	1.92 sq. ft.	2.51 sq. ft.	1.92 sq. ft.	3.09 sq. ft.	4.39 sq. ft.	3.09 sq. ft.	3.84 sq. ft.	5.76 sq. ft.	7.68 sq. ft.
Slip Fitter Mount 	Vertical	2.59 sq. ft.	3.19 sq. ft.	2.59 sq. ft.	3.80 sq. ft.	4.07 sq. ft.	3.80 sq. ft.	5.18 sq. ft.	7.77 sq. ft.	10.35 sq. ft.

ORDERING INFORMATION

ORDER CODE	PACK QTY.	UPC	Easy Code
AL-LED-L1-3-290-840-NM	1	843654135687	HRX-85
AL-LED-L1-3-290-850-NM	1	843654135694	AML-53
AL-LED-L1-5-290-840-NM	1	843654135700	DTM-51
AL-LED-L1-5-290-850-NM	1	843654135717	IGH-92