

WP-LED-TM-35-8CSB

TRADITIONAL 35W NON-CUTOFF LED WALL PACK



Traditional 35W, 120-277V Input

PRODUCT FEATURES

- Traditional design matches appearance and light distribution pattern of legacy HID, optimized for one-for-one replacements
- Heavy-duty, die-cast aluminum housing with (5) available 1/2" threaded conduit hubs: (1) on back and (1) on all four sides
- Powered by 0–10V dimming LED drivers
- CCT Selection: Adjustable CCT (3000K, 4000K, or 5000K)
- Built-in dusk-to-dawn photocell behind translucent 3/4" threaded plug with anti-yellowing agent
- Borosilicate glass lens diffuses light source and provides uniform distribution
- Covers footprint of mid-size HID wallpacks
- Ambient operating temperature: –40°C/–40°F to 50°C/122°F
- UL listed for wet locations, IP65
- 0–10V dimming, 10% min
- Power Factor: >0.95
- THD: <20%
- LED chip lifetime: L70 >100,000 hrs @ 25°C/77°F ambient fixture temp
- Meets FCC Part 15, Part B, Class A standards for conducted and radiated emissions
- Fixture impact rating IK06
- Compatible with LED Emergency Backups



10YEAR
LIMITED WARRANTY

ELECTRICAL SPECIFICATIONS

Catalog Number	Wattage	Lumens	Lumens Below 90°	Dimming	CCT*	Efficacy	CRI	Housing Color	Input Voltage	Rated Life	Legacy Equivalent
WP-LED-TM-35-8CSB	35W	4885 lm	4400 lm	0–10V	3000K	140 lm/W	>80	Bronze	120–277V	50,000 hrs	150W MH
		5460 lm	4910 lm		4000K	156 lm/W					
		5010 lm	4505 lm		5000K	143 lm/W					

* Color Uniformity: CCT (Correlated Color Temperature) range as per guidelines outlined in ANSI C78.377-2017

WP-LED-TM-35-8CSB

TRADITIONAL 35W NON-CUTOFF LED WALL PACK

PHOTOMETRIC SPECIFICATIONS

ISOCANDELA PLOT

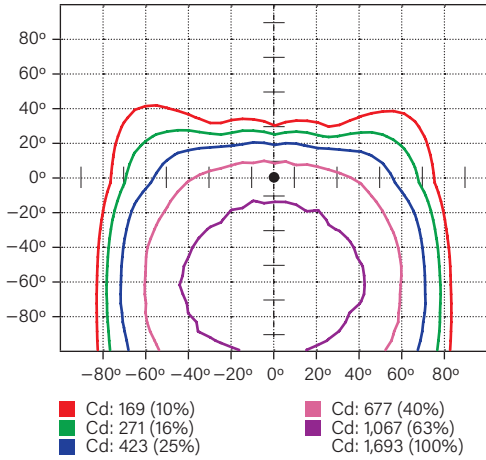

LUMINOUS INTENSITY DISTRIBUTION

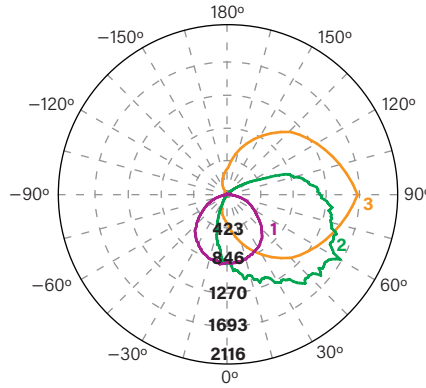

Average diffuse angle (50%): **111.0°**

1 Violet C0 - C180

2 Green C90 - C270

3 Orange G60

Unit: cd

FLUX DISTRIBUTION

Zone	Lumens	% Luminaire
Forward Light	3,845 lm	79.5%
0°-30°	591 lm	12.2%
30°-60°	1,673 lm	34.6%
60°-80°	1,166 lm	24.1%
80°-90°	416 lm	8.6%
Back Light	507 lm	10.5%
0°-30°	210 lm	4.4%
30°-60°	227 lm	4.7%
60°-80°	59 lm	1.2%
80°-90°	10 lm	0.2%
Up Light	481 lm	9.9%
90°-100°	215 lm	4.4%
100°-180°	267 lm	5.5%

BUG* Rating

Asymmetrical Luminaire Types

Type I, II, III, IV B1 U3 G3

Quadrilateral Symmetrical Luminaire Types

Type V, Area Light B1 U3 G3

* Backlight, Uplight, Glare

MOUNTING

Side view

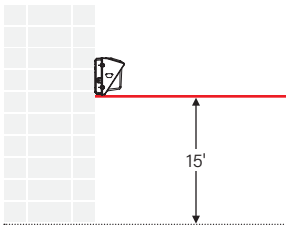

LIGHT DISTRIBUTION PATTERN

Isometric view from above; Luminaire mounted at 15'

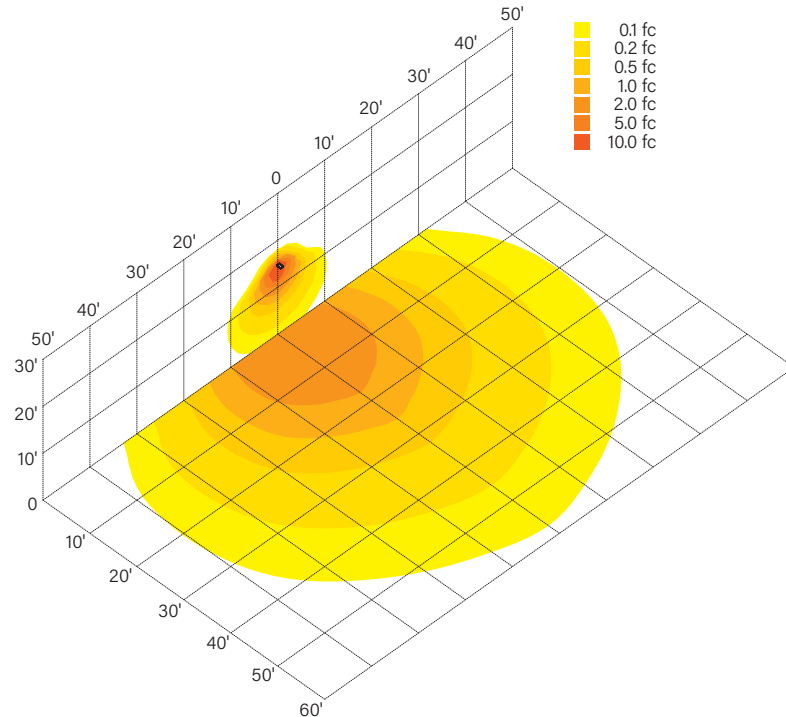

WP-LED-TM-35-8CSB

TRADITIONAL 35W NON-CUTOFF LED WALL PACK

PHYSICAL SPECIFICATIONS

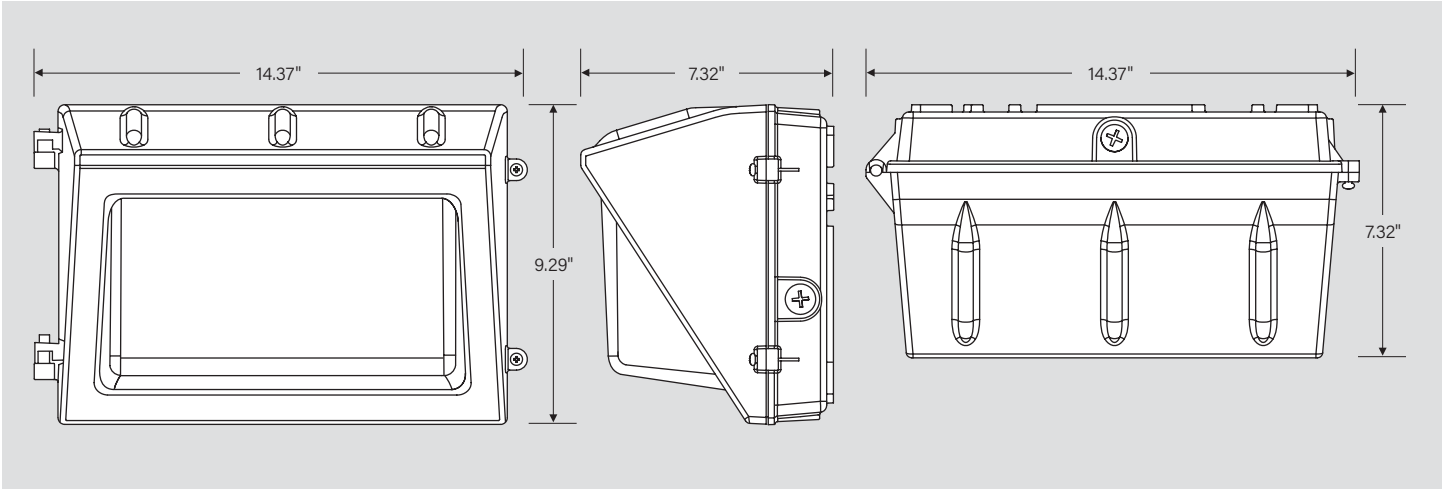

GENERAL SETUP INSTRUCTIONS

GENERAL WIRING DIAGRAM

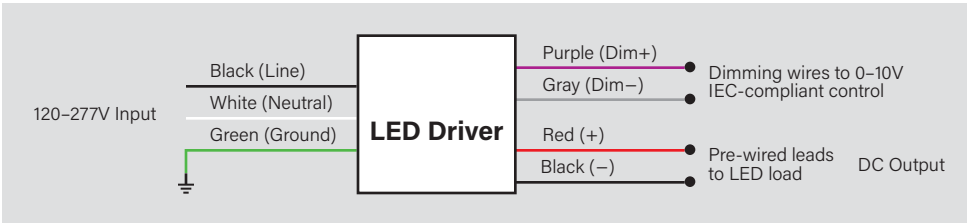

Caution: Before installing, make certain that AC power to the fixture is off.

Caution: The electrical rating of this product is 120-277V. Installer must confirm that there is 120-277V at the fixture before installation.

PHOTOCELL ENABLE / DISABLE

This fixture is equipped with a dusk-to-dawn photocell behind the translucent knock-out (KO) cover. Adjust the dip switch to enable (ON) or disable (OFF) the photocell function (see illustrations to the right). Fixture comes preset with photocell enabled unless otherwise noted.

(CCT) ADJUSTMENT

This fixture is equipped with CCT Selection. There is an adjustable dip switch behind the translucent knock-out (KO) cover to change CCT between 5000K, 4000K, and 3000K (see illustrations to the right). Fixture comes preset at 5000K unless otherwise noted.

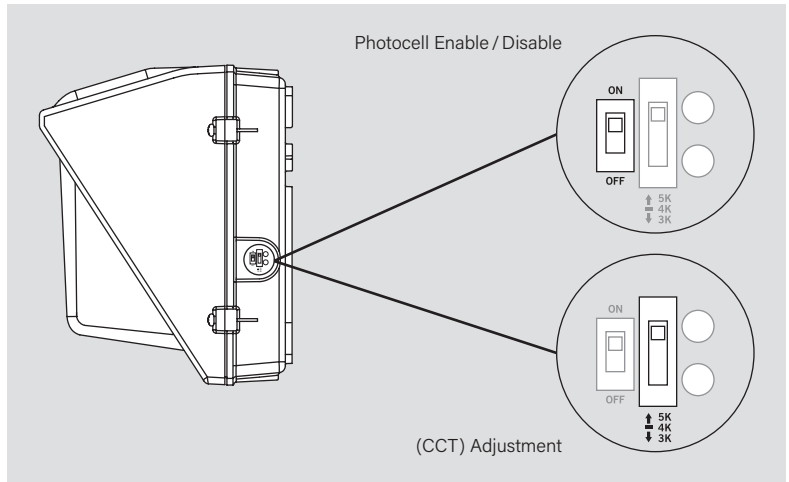

WP-LED-TM-35-8CSB

TRADITIONAL 35W NON-CUTOFF LED WALL PACK

ACCESSORIES

SENSORS

Factory-Installable OR Field-Installable (field-installable purchased separately)

✓	SUFFIX*	CATALOG NUMBER	DESCRIPTION	UPC	EASY CODE
	/MW3	KTS-MW3-UV-KO-K1	Microwave Sensor Kit, Includes 120-277V input to 12V DC convertor & 12V input sensor head, IP65. Bi-Level Control with Adjustable Hold Time, Dim Level and Standby Time. Installs via standard 1/2in KO	843654134147	BKG-51



* For factory installation of accessory, add suffix to fixture part number (see ordering examples and instructions on last page of spec sheet).

CORD SETS

Factory-Installable OR Field-Installable (field-installable purchased separately)

✓	SUFFIX*	CATALOG NUMBER	DESCRIPTION	UPC	EASY CODE
	/515P6	KT-CS-515P-6-18/3	Cord set for high bay; 125V NEMA 5-15P; straight blade plug; 6' SJTOW cable; 18/3 wire	843654140124	UKH-26
	/L515P6	KT-CS-L515P-6-16/3	Cord set for high bays; 125V NEMA L5-15P; twist lock plug; 6' SJTOW cable; 16/3 wire	843654140186	POC-82

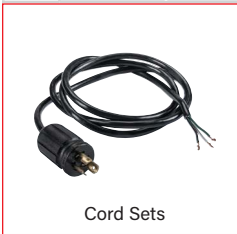

* For factory installation of accessory, add suffix to fixture part number (see ordering examples and instructions on last page of spec sheet).
Note: For cord sets not listed here, please contact your Keystone sales rep.

EMERGENCY BACKUP

Factory-Installable OR Field-Installable (field-installable purchased separately)

✓	SUFFIX*	CATALOG NUMBER	DESCRIPTION	UPC	EASY CODE
	/EM12	KT-EMRG-LED-12C-1200	LED Emergency Back-Up, 12W Constant Wattage Design. Approx 1200 Lumens. 120-277V Input. Remote Compact Battery Pack. CEC T20 Compliant.	843654103112	OJQ-32
	-	KT-EMRG-LED2-TS-IP65	IP65 Rated Wet Location Test Switch for 5W and 12W CEC Compliant LED Emergency Packs	843654130019	MDB-29

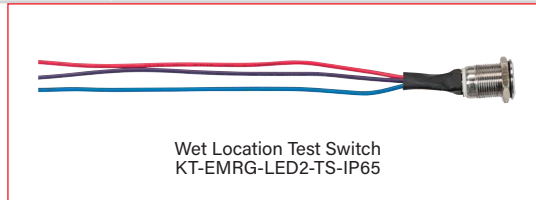

* For factory installation of accessory, add suffix to fixture part number (see ordering examples and instructions on last page of spec sheet).
† Factory installation of emergency backup units will automatically include any relevant mounting bracket.

(Accessories continued on next page)

WP-LED-TM-35-8CSB

TRADITIONAL 35W NON-CUTOFF LED WALL PACK

ACCESSORIES (continued)

MOUNTS AND BRACKETS

Field-Installable / Field-Use ONLY (purchased separately)

✓	SUFFIX*	CATALOG NUMBER	DESCRIPTION	UPC	EASY CODE
	-	KT-WPLED-BP-M	Back Plate for Medium Size Wallpacks, Covers Legacy Style Large HID Housing Dimensions. Standard Bronze Color.	843654130613	CCJ-21



Back Plate
KT-WPLED-BP-M

* For factory installation of accessory, add suffix to fixture part number (see ordering examples and instructions on last page of spec sheet).
Note: This is needed with EM - will be added when factory installing EM

SURGE PROTECTORS

Factory-Installable OR Field-Installable (field-installable purchased separately)

✓	SUFFIX*	CATALOG NUMBER	DESCRIPTION	UPC	EASY CODE
	/10KV	KTSP-10KV-C	External Surge Protector, compact design. Parallel Wiring, 120-277V Input, Max Peak Protection (10KV, 10KA)	843654129204	BUU-26



External Surge Protector
KTSP-10KV-C

* For factory installation of accessory, add suffix to fixture part number (see ordering examples and instructions on last page of spec sheet).

WP-LED-TM-35-8CSB

TRADITIONAL 35W NON-CUTOFF LED WALL PACK

ORDERING INFORMATION

CATALOG NUMBER	PACK QTY.	UPC
WP-LED-TM-35-8CSB	1	843654133577

CATALOG NUMBER BREAKDOWN

WP-LED-TM-35-8CSB

1	2	3	4	5	6	7	8
---	---	---	---	---	---	---	---

1 Wall Pack Fixture	3 Style
2 LED	T Traditional
3 Style	
4 Size	4 Size
5 Wattage	M Medium
6 80 CRI	
7 CCT Selectable	8 CCT Designation
8 CCT Designation	B 3000/4000/5000K

ORDERING EXAMPLES

FIXTURE WITH MULTIPLE FACTORY-INSTALLED ACCESSORIES*

WP-LED-TM-35-8CSB /MW3/515P6/EM12



FIXTURE WITH SINGLE FACTORY-INSTALLED ACCESSORY

WP-LED-TM-35-8CSB /MW3



FIXTURE WITH NO FACTORY-INSTALLED ACCESSORIES

WP-LED-TM-35-8CSB



* When ordering more than one factory-installed accessory, use multiple suffixes as shown in the ordering examples above.
Note: All accessories can also be ordered separately for field installation using just their regular Catalog Number, UPC, or Easy Code.

KEYSTONE FIXTURE

CATALOG NUMBER
WP-LED-TM-35-8CSB

SENSORS

<input checked="" type="checkbox"/>	SUFFIX	CATALOG NUMBER
<input checked="" type="checkbox"/>	/MW3	KTS-MW3-UV-KO-K1

CORD SETS

<input checked="" type="checkbox"/>	SUFFIX	CATALOG NUMBER
<input checked="" type="checkbox"/>	/515P6	KT-CS-515P-6-18/3

EMERGENCY BACKUP

<input checked="" type="checkbox"/>	SUFFIX	CATALOG NUMBER
<input checked="" type="checkbox"/>	/EM12	KT-EMRG-LED-12C-1200